

# ***Soltron V-55 Big Apple***



**Forever Tan**  
113 Freeland Lane  
Charlotte, NC 28217  
1-800-447-0040

**For questions concerning this guide please  
contact Andy Turner:**

**andy.turner@forevertan.net**  
**1-800-467-5473 direct**  
**704-971-4748 local**  
**704-607-4243 cell**

# Electrical – 7 pages

\* This unit requires a 230 volts, three-phase, 40 amp (4 wire) circuit - actual amp draw of 29 amps - This unit has approximately 5 ft. of # 8 AWG wire (3 hots, 1 ground) coming out of the left side of the back panel through a 1-inch liquid-tight flex connector. This wire must be sleeved with flex and brought into a junction box. *Do not shorten wire, as this additional length is necessary to move the bed for service.* Contact a licensed electrician. Check local code for disconnect requirements.

\* If three-phase power is not available this unit can be converted to a single-phase unit. The unit will then have approximately 5 ft. of # 4 AWG wire (2 hots, 1 ground) coming out through the 1-inch liquid-tight flex connector. It will then require a 230-volt, 70 amp, (3 wire) circuit – actual amp draw of 50 amps.

*If you require a unit to be single phase you must contact the Forever Tan Delivery Department before delivery at 1-800-447-0040.*

*All locations are given as if you were standing in front of the bed or unit.*

## **\*\*\* IMPORTANT \*\*\***

***If 230 volts are not available a transformer will be required.***

Transformers are not included in the price of the bed/unit and must be purchased separately. Transformers are available from the Forever Tan Parts Department.

Forever Tan also sells “Panel Boosting” Transformers. These are available in 200, 400, 600 and 800 amp versions. If multiple units require boosting it may be more cost effective to boost a whole panel instead of using individual transformers for each unit/bed. Please allow 6 to 8 weeks lead time for these transformers.

***It is the contractor or owner’s responsibility to purchase and provide a location and hook-up of any transformers.***

## **Junction Box Placement**

Left side – 84” up

These measurements are where the *conductors* come out of the *back* of the unit and are given as if you are standing in *front* of the equipment. The junction boxes should be placed within 1 foot of this. *These conductors must be sleeved with liquid tight flex.*

**\*\*\*Forever Tan does not do any electrical wiring. The electrician must do the pre-wiring then return for the final hook-up during the equipment installation. This includes the wiring of any transformers.**

**\*\*\*Due to insurance and liability reasons NO employee of Forever Tan is allowed (either written or verbally) to include any wiring with the purchase of tanning equipment from Forever Tan.**

**\*\*\*Employees of Forever Tan do not mount timers or body fans to walls.**

**\*\*\*The factory is allowed by ETL to size the wire coming out of the beds to match the amp draw not the size of the circuit (Appliance Rule). Wire gauges may be smaller (or larger for phase conversion purposes) than listed for circuit.**

**\*\*\* All information concerning wire gauge and breaker size are calculated using the NEC table B-310-1 for 75 degree Celsius wire no more than three conductors in a raceway or cable in free air. Electrical contractors should verify all information on wire gauge and breaker sizes. Forever Tan will take no responsibility for any miscalculations or any misprints.**

**\*\*\* Forever Tan will allow all beds to be cord and plug connected. Forever Tan requires that the conversion from hard-wire to cord and plug be made externally. Forever Tan will not provide materials and/or labor for any conversions.**

**\*\*\*All information is subject to change at the manufactures and Forever Tan's discretion.**

**If you have any questions please e-mail Andy Turner at [andy.turner@forevertan.net](mailto:andy.turner@forevertan.net) or at 1-800-467-5473.**

## **Single-Phase Transformers**

**Forever Tan sells the Dongan Model 85-LM050 for this application.  
Call Forever Tan Parts Department for Pricing – 1-800-447-0040**

**There are cut sheets available at [www.dongan.com](http://www.dongan.com)**

**The measurements are 15 ¼ " H x 8 ¼ " W x 8"D**

**The weight is 69 lbs.**

**The wiring diagram will be included.**

# 40 amp rated – Jefferson 415-0001-041 (3 Phase 208Y to 235Y volts)

**Call Forever Tan Parts Department for Pricing – 1-800-447-0040**

OUTPUT AMPS	CATALOG NUMBER	INPUT VOLTAGE	OUTPUT VOLTAGE	INSULATION CLASS	TEMP. RISE	WINDING MATERIAL	HERTZ	PHASE	ENCLOSURE	APPROX. SHIP WT.
30	415-0001-056	208Y	235Y	180	135	COPPER	60	3	NEMA 3R	43
40	415-0001-041	208Y	235Y	180	135	COPPER	60	3	NEMA 3R	47
50	415-0001-042	208Y	235Y	180	135	COPPER	60	3	NEMA 3R	51
60	415-0001-040	208Y	235Y	180	135	COPPER	60	3	NEMA 3R	55
80	415-0001-043	208Y	235Y	180	135	COPPER	60	3	NEMA 3R	62

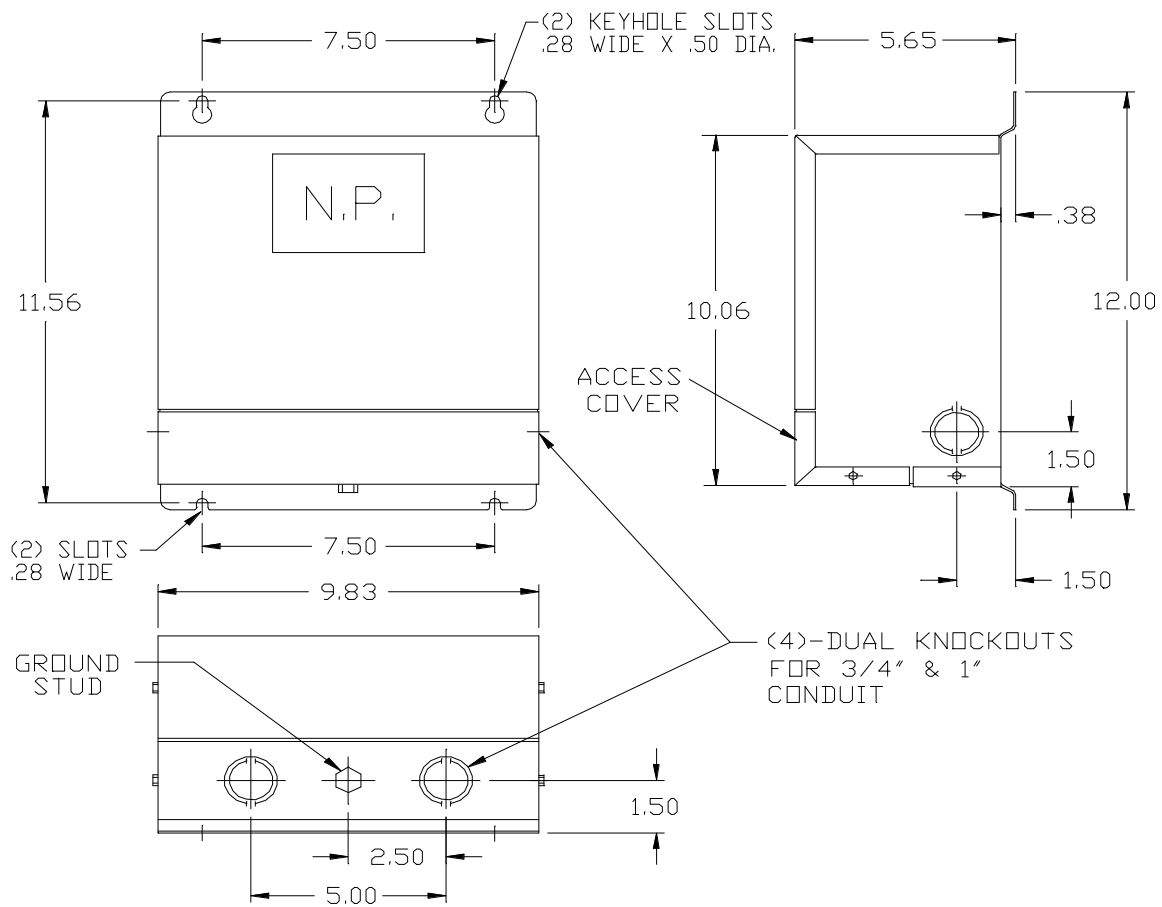

### WIRING DIAGRAM

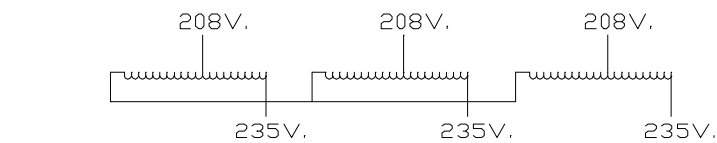

INPUT: 208V.  
OUTPUT: 235V



SCALE: NONE	DATE
DWN BY: G.D. CHAIGNOT	05/11/04
APVD BY: R. ZIMMERMAN	05/11/04

OUTLINE DRAWING  
ENCAPSULATED AUTO  
TRANSFORMER

REVISION  
REV.B:- ADDED 30 AMP RATING.  
G.D. CHAIGNOT 05/21/04

APVD  
GC/RZ  
05/21/04

PCD 415-0000-009 | B

## **TIMER WIRING INFORMATION**

The cable required for the “*Single Station*” remote timers is a 4 conductor 24 AWG flat cable commonly known as “Silver Satin”. It can be purchased from Forever Tan Service Department for \$.08 per foot.

The cable required for the CCS IV “*Back-Bone System*” is a 4 conductor 24 gauge shielded cable. It can be purchased from Forever Tan Service Department at the rate \$95.00 for 1000 ft. or \$65.00 for 500 ft.

The “*Back-Bone System*” is used when networking multiple beds to the Intellitan CCS IV or T-Max Manager Pro main station timer. The “*Back-Bone System*” utilizes a single continuous run of 4 conductor 24 gauge shielded cable that starts in a single-gang box near the mounting location of the CCS IV or T-Max Manager Pro main station timer, from there it loops through (12 inches, uncut) single-gang boxes in each room and terminates in a single-gang box in the last room. After the cable has been pulled and looped through each box a 110 punch-down jack (AMP 41106-RI6) is installed on the cable (using a punch-down style jack eliminates the need to cut the cable). The jack is then mounted to the faceplate (AMP 41080-1IP) the faceplate is then attached to the single-gang box. The jacks may be purchased from Forever Tan Service Department for \$3.00 each and the faceplates for \$2.00 each. Forever Tan Service Department will install the jacks and plates (at the time of delivery of the units) for an additional \$5.00 per room, provided that the cable and the single-gang boxes have already been installed by you (the owner) or your electrician PRIOR to the delivery of your tanning units. (See diagrams.). **IMPORTANT NOTE;** The CCS IV or T-Max Manager Pro main station timer requires a 120-volt outlet within 4 feet of where the timer will be mounted. This does not have to be a dedicated circuit.

**See individual diagrams for placement of outlet boxes.**

### **IMPORTANT**

Forever Tan does not do any pre-wiring or installing of timer wires. We recommend having an electrician do this for you. The wire is available from the Forever Tan Parts Department.

No employee of Forever Tan is allowed (either written or verbally) to include any timer wiring with any purchase of tanning equipment from Forever Tan.

**Forever Tan will (for additional charge) terminate the timer connections upon delivery of the beds/equipment if the pre-wiring is complete.**

### BACK-BONE TIMER WIRING DIAGRAM

ELECTRICAL CONNECTION:  
JUNCTION BOX MOUNTED  
12-18 INCHES OFF FLOOR  
WITH THE APPROPRIATE  
DEDICATED CIRCUIT  
PULLED INTO IT.

SINGLE GANG OUTLET BOX  
WITH A 12 INCH LOOP (UNCUT)  
OF 24 GAUGE 4 CONDUCTOR  
SHIELDED WIRE.

\*\* SEE INDIVIDUAL DIAGRAMS  
FOR RECOMMENED PLACEMENT  
OF OUTLET BOXES

CCS IV MAIN STATION REMOTE  
TIMER

SINGLE GANG OUTLET BOX -  
THIS IS WHERE THE 24 GAUGE 4  
CONDUCTOR SHIELDED CABLE  
MUST START FROM.

120 VOLT OUTLET WITHIN  
4 FEET OF WHERE THE  
TIMER WILL BE PLACED.

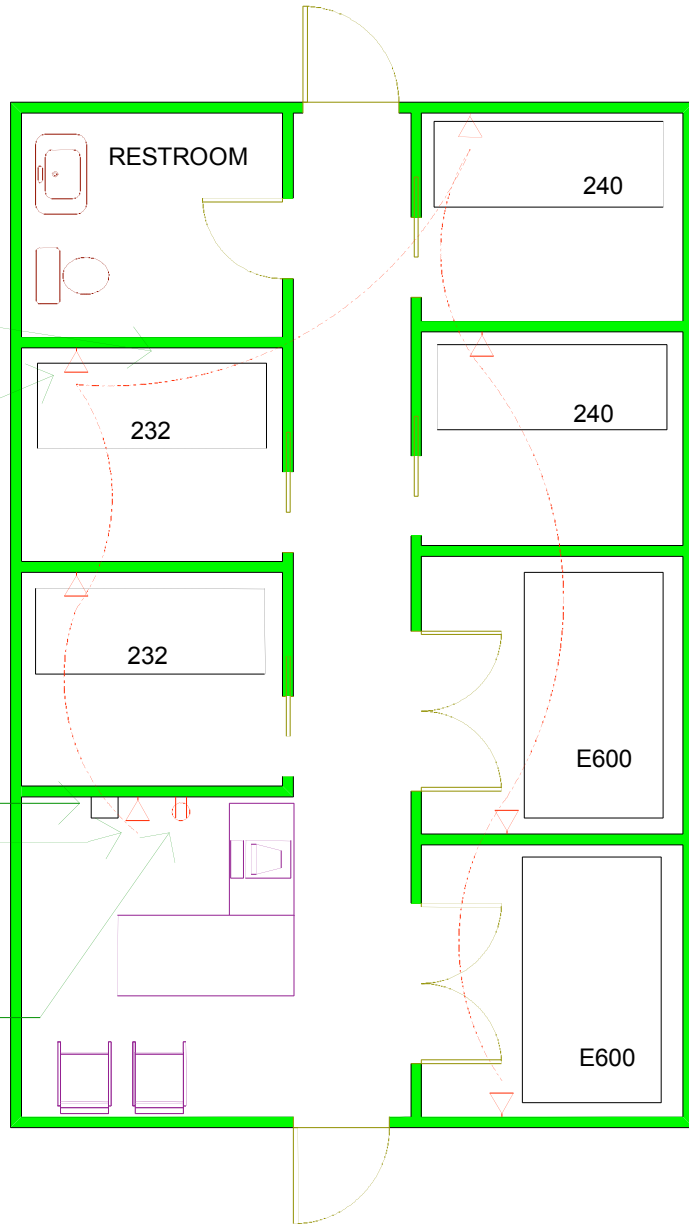

**Forever Tan does not mount timers on walls**

Placement of single gang box containing network wire for the following equipment models:

Vertical, Sunrise, Soltron V-Series

This placement is center of the side wall and 84 inches off the floor.

Side wall

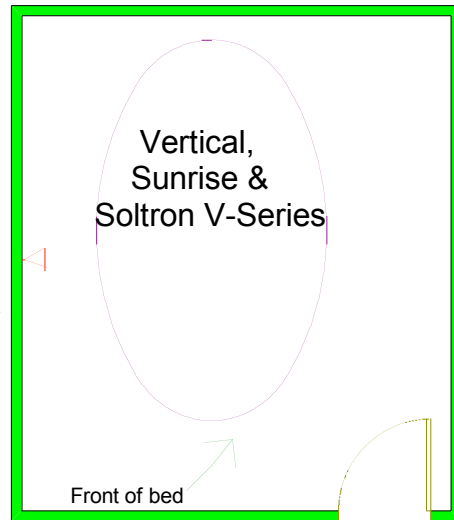

**This unit requires a minimum room size of 8 x 7. The hallway should be a minimum of 48" wide with a doorway size of at least 36". This unit requires a minimum ceiling clearance of 10 ft.**

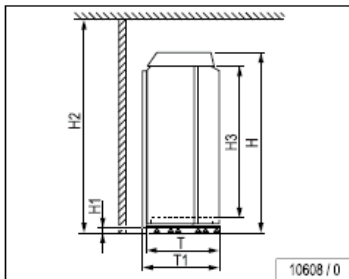

10608 / 0

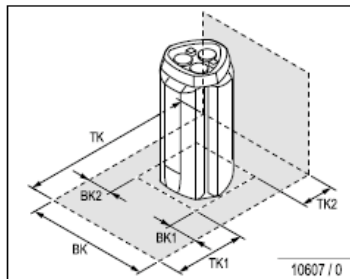

10607 / 0

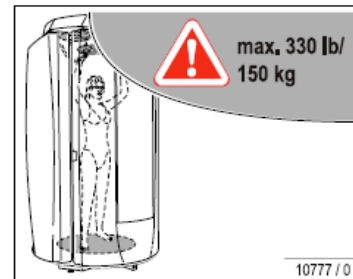

10777 / 0

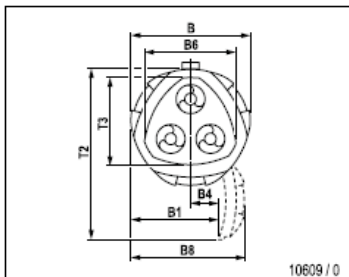

10609 / 0

B = 54 13/16 in	TK = 94 1/2 in
B1 = 34 1/8 in	TK1 = 34 5/8 in
B4 = 6 9/16 in	TK2 = 11 13/16 in
B6 = 34 in	
B8 = 53 13/16 in	BK = 76 3/16 in
T = 50 3/8 in	BK1 = 19 11/16 in
T1 = 54 5/16 in	BK2 = 19 11/16 in
T2 = 72 5/16 in	
T3 = 34 1/16 in	
H = 92 3/16 in	
H1 = 2 11/16 in	
H2 = 108 1/4 in	
H3 = 79 1/2 in	

B = 1,392 mm	TK = 2,400 mm
B1 = 866 mm	TK1 = 880 mm
B4 = 166 mm	TK2 = 300 mm
B6 = 864 mm	
B8 = 1,367 mm	BK = 1,935 mm
T = 1,279 mm	BK1 = 500 mm
T1 = 1,380 mm	BK2 = 500 mm
T2 = 1,837 mm	
T3 = 865 mm	
H = 2,341 mm	
H1 = 69 mm	
H2 = 2,750 mm	
H3 = 2,020 mm	

**Audio**  
**Internal speakers**

**Internal speakers**

**This unit has two 8-ohm speakers installed in the canopy. There is a volume control on the display. The power to drive these speakers must come from an outside source (not provided with the equipment and not available from Forever Tan). The wiring should be brought to the top of the unit with at least 6 feet of slack to reach the terminals inside the bed.**

**If a music source is to be used the audio installer must have the wiring in place before delivery and must be present when the equipment is installed. Forever Tan has to turn on this feature and adjust the input volume so that it will conform to the volume of the source.**

# Soltron V-55 Big Apple

## *HVAC – 1 page*

This unit produces 34800 BTU's of heat per hour. The factory recommends a minimum 1.7 tons of A/C to offset the heat produced by this unit.

***Please consult a Mechanical Contractor.***

The heat is exhausted out the back of the unit and is forced straight up by 3 fans.

### **Open Ceiling vs. Dropped Ceiling**

Forever Tan has found that (if feasible) it is best to leave the ceiling open. If the ceiling is open and the A/C is piped down it allows the heat to rise past cool air. This makes it easier for the cool air to reach the floor. A dropped ceiling traps the heat and makes it harder for the cool air to reach the floor (it also warms your cool air before it has a chance to reach the floor). When an open ceiling is used the Mechanical Contractors should run all hard ductwork. This will consist of a main trunk line with 8"-12" round pipe dropped over each room (hard duct allows it to be painted).

**If you have any questions please e-mail Andy Turner at [andy.turner@forevertan.net](mailto:andy.turner@forevertan.net) or at 1-800-467-5473.**