

Ergoline Inspiration 450

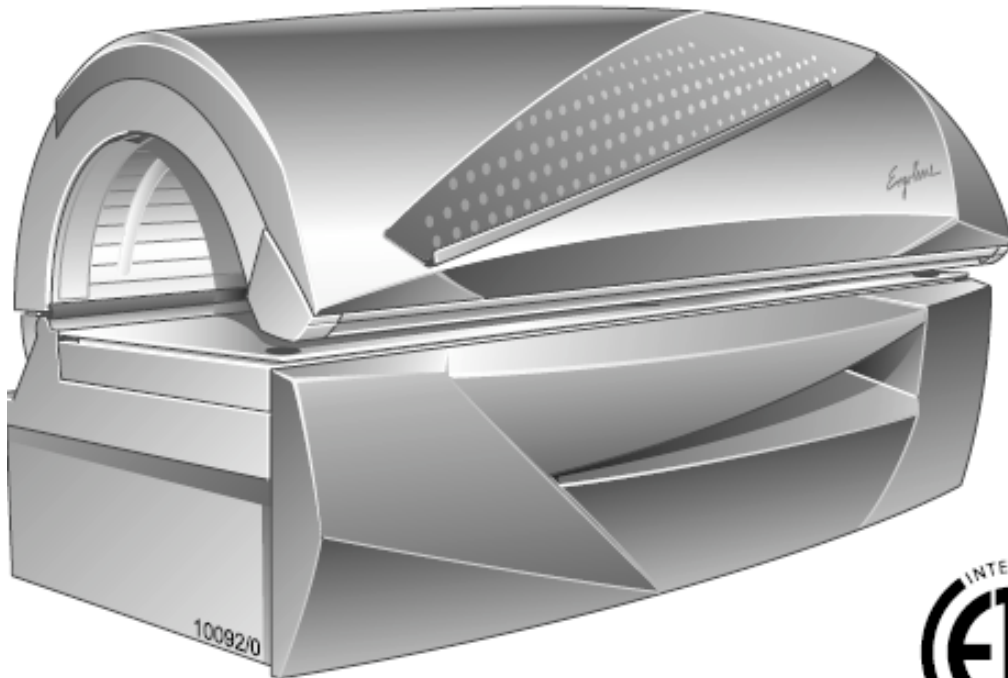

Forever Tan
113 Freeland Lane
Charlotte, NC 28217
1-800-447-0040

**For questions concerning this guide please
contact Andy Turner:**

andy.turner@forevertan.net
1-800-467-5473 direct
704-971-4748 local
704-607-4243 cell

Electrical – 7 pages

* This unit requires a 230 volts, three-phase, 40 amp (4 wire) circuit - actual amp draw of 28 amps - This unit has approximately 5 ft. of # 8 AWG wire (3 hots, 1 ground) coming out of the left side of the back panel through a 1-inch liquid-tight flex connector. This wire must be sleeved with flex and brought into a junction box. *Do not shorten wire, as this additional length is necessary to move the bed for service.* Contact a licensed electrician. Check local code for disconnect requirements.

* If three-phase power is not available this unit can be converted to a single-phase unit. The unit will then have approximately 5 ft. of # 6 AWG wire (2 hots, 1 ground) coming out through the 1-inch liquid-tight flex connector. It will then require a 230-volt, 60 amp, (3 wire) circuit – actual amp draw of 48 amps.

If you require a unit to be single phase you must contact the Forever Tan Delivery Department before delivery at 1-800-447-0040.

All locations are given as if you were standing in front of the bed or unit.

***** IMPORTANT *****

If 230 volts are not available a transformer will be required.

Transformers are not included in the price of the bed/unit and must be purchased separately. Transformers are available from the Forever Tan Parts Department.

Forever Tan also sells “Panel Boosting” Transformers. These are available in 200, 400, 600 and 800 amp versions. If multiple units require boosting it may be more cost effective to boost a whole panel instead of using individual transformers for each unit/bed. Please allow 6 to 8 weeks lead time for these transformers.

It is the contractor or owner’s responsibility to purchase and provide a location and hook-up of any transformers.

Junction Box Placement

11” from left side – 17” up

These measurements are where the *conductors* come out of the *back* of the unit and are given as if you are standing in *front* of the equipment. The junction boxes should be placed within 1 foot of this. *These conductors must be sleeved with liquid tight flex.*

*****Forever Tan does not do any electrical wiring. The electrician must do the pre-wiring then return for the final hook-up during the equipment installation. This includes the wiring of any transformers.**

*****Due to insurance and liability reasons NO employee of Forever Tan is allowed (either written or verbally) to include any wiring with the purchase of tanning equipment from Forever Tan.**

*****Employees of Forever Tan do not mount timers or body fans to walls.**

*****The factory is allowed by ETL to size the wire coming out of the beds to match the amp draw not the size of the circuit (Appliance Rule). Wire gauges may be smaller (or larger for phase conversion purposes) than listed for circuit.**

***** All information concerning wire gauge and breaker size are calculated using the NEC table B-310-1 for 75 degree Celsius wire no more than three conductors in a raceway or cable in free air. Electrical contractors should verify all information on wire gauge and breaker sizes. Forever Tan will take no responsibility for any miscalculations or any misprints.**

***** Forever Tan will allow all beds to be cord and plug connected. Forever Tan requires that the conversion from hard-wire to cord and plug be made externally. Forever Tan will not provide materials and/or labor for any conversions.**

*****All information is subject to change at the manufactures and Forever Tan's discretion.**

If you have any questions please e-mail Andy Turner at andy.turner@forevertan.net or at 1-800-467-5473.

Single-Phase Transformers

**Forever Tan sells the Dongan Model 85-MO40 for this application.
Call Forever Tan Parts Department for Pricing – 1-800-447-0040**

**There are cut sheets available at www.dongan.com
The measurements are 15 ¼" H x 5 ¾" W x 5 ¾" D
The weight is 39 lbs.
The wiring diagram will be included.**

40 amp rated - Jefferson 415-0001-041

(3 Phase 208Y to 235Y volts)

Call Forever Tan Parts Department for Pricing - 1-800-447-0040

OUTPUT AMPS	CATALOG NUMBER	INPUT VOLTAGE	OUTPUT VOLTAGE	INSULATION CLASS	TEMP. RISE	WINDING MATERIAL	HERTZ	PHASE	ENCLOSURE	APPROX. SHIP WT.
30	415-0001-056	208Y	235Y	180	135	COPPER	60	3	NEMA 3R	43
40	415-0001-041	208Y	235Y	180	135	COPPER	60	3	NEMA 3R	47
50	415-0001-042	208Y	235Y	180	135	COPPER	60	3	NEMA 3R	51
60	415-0001-040	208Y	235Y	180	135	COPPER	60	3	NEMA 3R	55
80	415-0001-043	208Y	235Y	180	135	COPPER	60	3	NEMA 3R	62

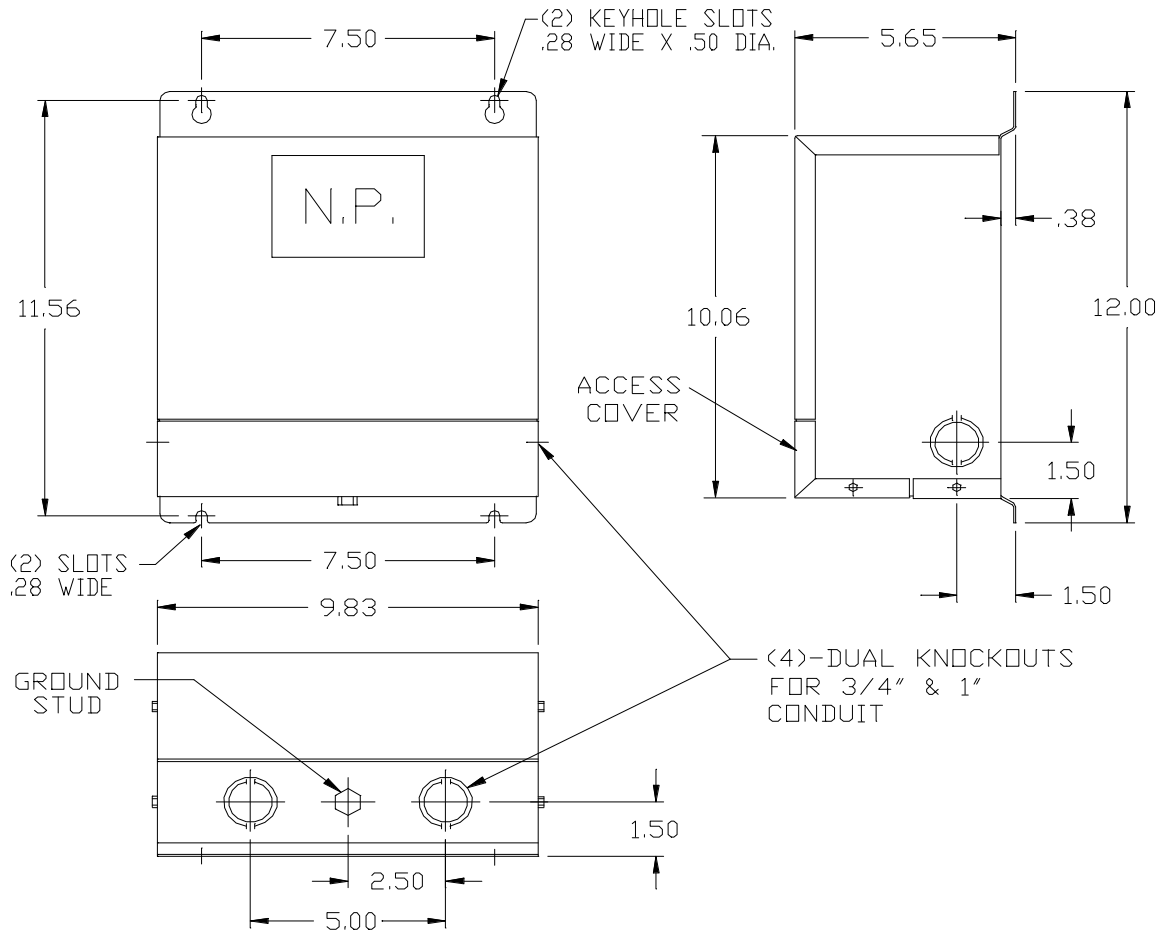

WIRING DIAGRAM

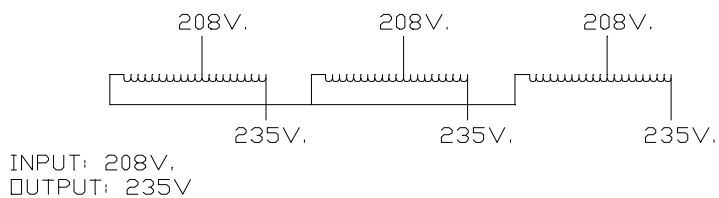

SCALE: NONE	DATE
DWN BY: G.D. CHAIGNOT	05/11/04
APVD BY: R. ZIMMERMAN	05/11/04

OUTLINE DRAWING
ENCAPSULATED AUTO
TRANSFORMER

REVISION
REV.B:- ADDED 30 AMP RATING.
G.D. CHAIGNOT 05/21/04

APVD
GC/RZ
05/21/04

PCD 415-0000-009 | B

TIMER WIRING INFORMATION

The cable required for the “*Single Station*” remote timers is a 4 conductor 24 AWG flat cable commonly known as “Silver Satin”. It can be purchased from Forever Tan Service Department for \$.08 per foot.

The cable required for the CCS IV “*Back-Bone System*” is a 4 conductor 24 gauge shielded cable. It can be purchased from Forever Tan Service Department at the rate \$95.00 for 1000 ft or \$65.00 for 500 feet.

The “*Back-Bone System*” is used when networking multiple beds to the Intellitan CCS IV or T-Max Manager Pro main station timer. The “*Back-Bone System*” utilizes a single continuous run of 4 conductor 24 gauge shielded cable that starts in a single-gang box near the mounting location of the CCS IV or T-Max Manager Pro main station timer, from there it loops through (12 inches, uncut) single-gang boxes in each room and terminates in a single-gang box in the last room. After the cable has been pulled and looped through each box a 110 punch-down jack (AMP 41106-RI6) is installed on the cable (using a punch-down style jack eliminates the need to cut the cable). The jack is then mounted to the faceplate (AMP 41080-1IP) the faceplate is then attached to the single-gang box. The jacks may be purchased from Forever Tan Service Department for \$3.00 each and the faceplates for \$2.00 each. Forever Tan Service Department will install the jacks and plates (at the time of delivery of the units) for an additional \$5.00 per room, provided that the cable and the single-gang boxes have already been installed by you (the owner) or your electrician PRIOR to the delivery of your tanning units. (See diagrams.). **IMPORTANT NOTE;** The CCS IV or T-Max Manager Pro main station timer requires a 120-volt outlet within 4 feet of where the timer will be mounted. This does not have to be a dedicated circuit.

See individual diagrams for placement of outlet boxes.

IMPORTANT

Forever Tan does not do any pre-wiring or installing of timer wires. We recommend having an electrician do this for you. The wire is available from the Forever Tan Parts Department.

No employee of Forever Tan is allowed (either written or verbally) to include any timer wiring with any purchase of tanning equipment from Forever Tan.

Forever Tan will (for additional charge) terminate the timer connections upon delivery of the beds/equipment if the pre-wiring is complete.

Forever Tan does not mount timers on the walls.

BACK-BONE TIMER WIRING DIAGRAM

ELECTRICAL CONNECTION:
JUNCTION BOX MOUNTED
12-18 INCHES OFF FLOOR
WITH THE APPROPRIATE
DEDICATED CIRCUIT
PULLED INTO IT.

SINGLE GANG OUTLET BOX
WITH A 12 INCH LOOP (UNCUT)
OF 24 GAUGE 4 CONDUCTOR
SHIELDED WIRE.

** SEE INDIVIDUAL DIAGRAMS
FOR RECOMMENED PLACEMENT
OF OUTLET BOXES

CCS IV MAIN STATION REMOTE
TIMER

SINGLE GANG OUTLET BOX -
THIS IS WHERE THE 24 GAUGE 4
CONDUCTOR SHIELDED CABLE
MUST START FROM.

120 VOLT OUTLET WITHIN
4 FEET OF WHERE THE
TIMER WILL BE PLACED.

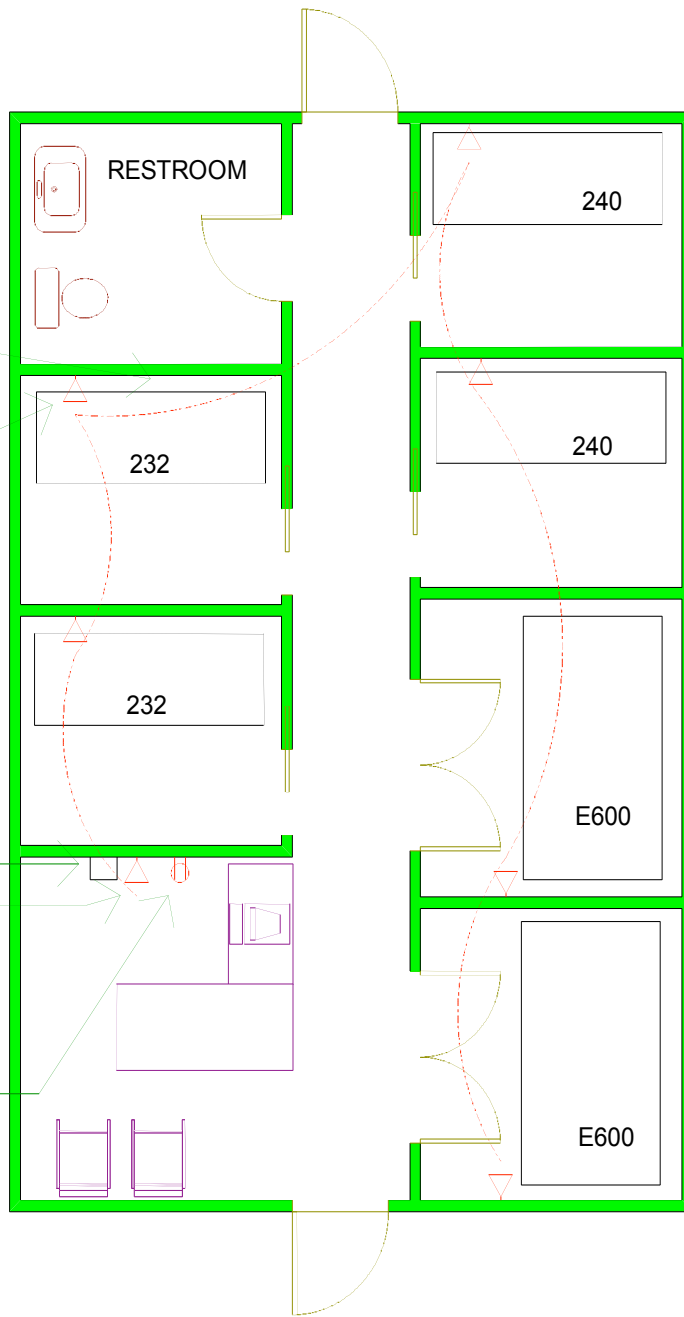

Placement of single gang box containing network wire for the following equipment models:

All Sundash , Ergoline and Soltron units.

This placement is approximately 12 inches off side wall and 24 inches from the floor

Side wall

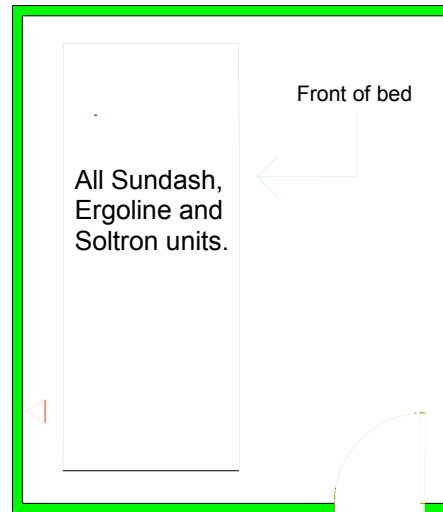

This unit requires a minimum room size of 10 x 9. The hallway should be a minimum of 48" wide and a double door or an opening of 5 feet.

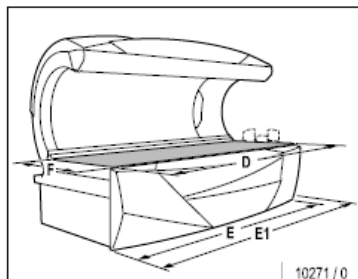
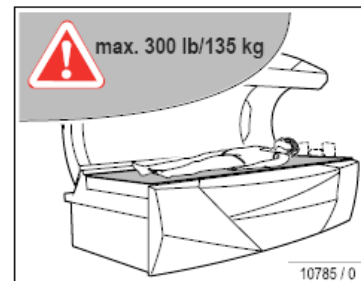
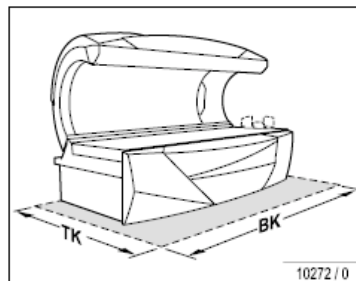
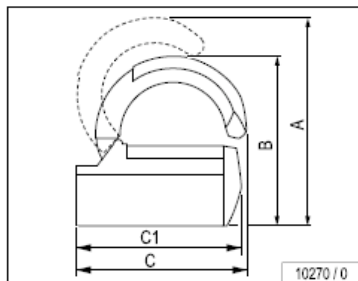

A =	64 in	1,625 mm
B =	51 5/16 in	1,304 mm
C =	56 1/4 in	1,428 mm
C1 =	55 5/16 in	1,421 mm
D =	88 9/16 in	2,250 mm
E =	89 3/8 in	2,270 mm
E1 =	93 5/16 in	2,370 mm
F =	32 11/16 in	830 mm
TK =	82 11/16 in	2,100 mm
BK =	94 1/2 in	2,400 mm

Audio/Video

VibraSound, 3D sound, Speaker Placement

This unit has VibraSound with volume control (internally amplified speakers that work with your salon's music source). VibraSound units can be configured to handle up to four music sources (Multi-Channel) with the addition of the optional DMS music adaptor (see below). Contact your salesman for more information.

If a music source is to be used the audio installer must have the wiring in place before delivery and must be present when the equipment is installed. Forever Tan has to turn on this feature and adjust the input volume so that it will conform to the volume of the source.

Important Information on the Multi-Channel System

If you want to use the channel selector in this unit there are three things that will be required.

1. A DMS Music adaptor. This will allow you to have up to four different sources of audio. This unit sells for \$300.00 and can be purchased from the Forever Tan parts department.
2. A standard 120-volt receptacle located behind the left side of the bed. This is to plug in the DMS Music Adaptor.
3. Audio source, this can be a Pre-amplifier, Power amplifier or 100 Volt systems.

Speaker Placement

If you choose to use an external speaker the location to the center will be on the wall to the right side of bed, 29" from back wall, 32" off the floor.

*Speaker placement was measured allowing 6 inches of clearance at the back of the unit for electrical hook-up. You may use the equipment measurements provided to draw a footprint of the unit on the floor of the room and determine where you want the speaker.

Ergoline Inspiration 450

HVAC – 1 page

This unit produces 37500 BTU's of heat per hour. The factory recommends a minimum 1.5 tons of A/C to offset the heat produced by this unit.

Please consult a Mechanical Contractor.

The heat is exhausted out the back of the unit and is forced straight up by a 1750cfm fan.

Open Ceiling vs. Dropped Ceiling

Forever Tan has found that (if feasible) it is best to leave the ceiling open. If the ceiling is open and the A/C is piped down it allows the heat to rise past cool air. This makes it easier for the cool air to reach the floor. A dropped ceiling traps the heat and makes it harder for the cool air to reach the floor (it also warms your cool air before it has a chance to reach the floor). When an open ceiling is used the Mechanical Contractors should run all hard ductwork. This will consist of a main trunk line with 8"-12" round pipe dropped over each room (hard duct allows it to be painted).

Alternative Venting Methods

This bed may be vented out of the room or even out of the building. Forever Tan Parts Department sells a vent kit that attaches to the exhaust outlet of the bed and includes a 20ft flexible duct. This kits sells for around \$425.00.

The kit does not have to be used; your mechanical contractor can customize an adaptor and attach it directly to the bed. ****The duct must be no less than 12" in diameter or overheating will occur****

***** If you choose to vent the heat out you can calculate the minimum A/C requirements at 25% less. The mechanical contractor should consider having a fresh air vent so a vacuum effect will not occur.**

*****Theses numbers are only recommendations, the mechanical contractor should calculate the A/C requirements, taking in to consideration the unique aspects of each space or building.**

If you have any questions please e-mail Andy Turner at andy.turner@forevertan.net or at 1-800-467-5473.